



The THEMYS line



YOUR VERSATILE PLATFORM



THERMAL ANALYSIS & APPLICATIONS

KEP Technologies is not simply an instrument company, but a full solution provider.

We do not claim that a single product is suited for all applications and have with our SETARAM brand developed a range of products with different characteristics to more closely meet your demands.

We are confident that with KEP Technologies you will find a dedicated thermal analysis solution with the performance you need to get the best understanding of your materials. This being the case no matter which of our below market segments you may work in.



ENERGY & ENVIRONMENT

Batteries materials thermal stability
Biomass pyrolysis and combustion
Sorption of CO₂ and other gases or vapors
Coal composition
Nuclear fuel and wastes thermal stability



INORGANIC MATERIALS SCIENCE

Thermal stability, compositional analysis of ceramics, minerals, building materials, nanomaterials
High temperature oxidation of metals, reduction of oxides
Phase diagrams, thermal expansion, sintering of ceramics and metals



ORGANIC MATERIALS SCIENCE

Thermal stability, compositional analysis of polymers and plastics.
Reverse engineering, Thermal recycling, Processes like pyrolysis



LIFE SCIENCES

Pharmaceutical materials: water content, residual solvents, thermal stability, reverse engineering



PROCESS SAFETY

Thermal stability of energetic materials, chemistry of thermal decompositions

THE KEP TECHNOLOGIES ADVANTAGE

Each THEMYS thermal analyser also embodies our "Reimagine Material Characterization" value proposition. It does so by delivering the three core customer benefits of Experimental Control, Instrument Versatility and Quality Results.

We know that solutions that provide these benefits will deliver the highest value to our customers.

In addition to our core customer benefits, we are able to provide customized solutions by harnessing the engineering and project management expertise of our highly skilled organization.

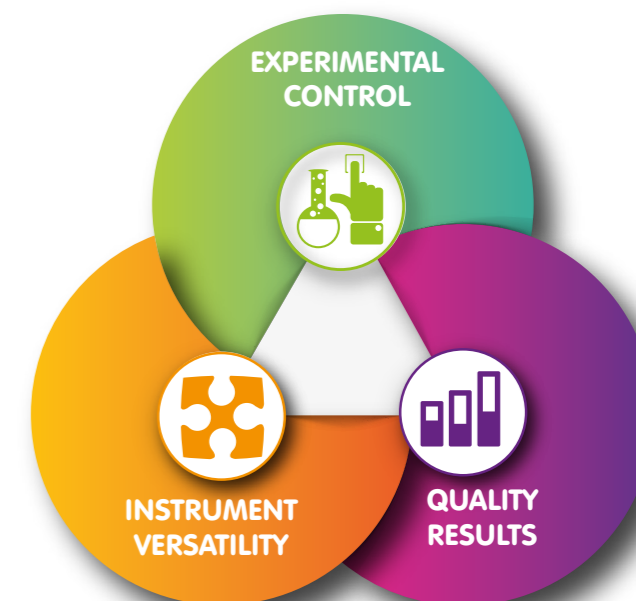

CUSTOMIZED SOLUTIONS

Modular design allows for upgraded and tailored functionality
Access to all previous non-proprietary custom requests
Open access to engineering development team

THE THEMYS LINE

Owing to their symmetrical beam balances, the THEMYS line of thermal analyzers combine the highest sensitivity, stability, and the most accurate measurements of mass variations vs temperature or time.

Most systems within the THEMYS family line provide the user with a high level of versatility thanks to a modular design. It may include the simultaneous measurement of heat flow and mass variations with the STA versions of the instruments, or the identification of evolved gases by coupling the instruments with gas analyzers, or the measurement of dimensional changes with a TMA module.

While horizontal thermobalances lead to perturbations of the mass variations and temperature signals when the sample transforms, the vertical design benefits from good stability.

When combined with the hang-down principle, the sample can be hung to the balance using very thin suspensions. They minimize the drift of the mass variation signal with temperature, which is also known as buoyancy effect.

Finally, the dual furnace version of hang-down balances are designed to directly subtract this drift from the mass variation signal and reach the best stability and thus the highest measurement accuracy possible.

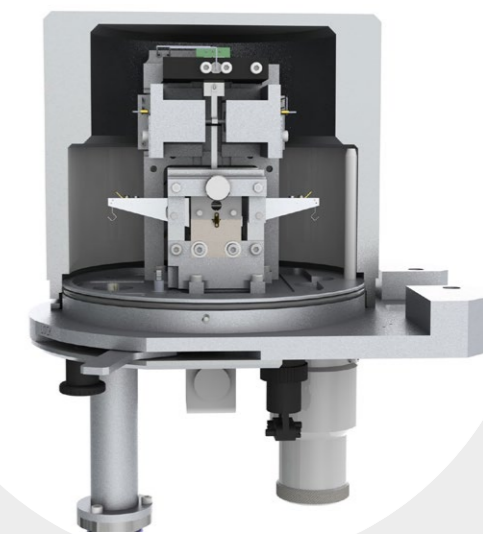

THEMYS LINE

Our range of instruments for the characterization of materials across wide temperature ranges and using all common thermal analysis techniques.



Ambient to 1200°C
High Pressure System
THEMYS HP



Ambient to 2000°C



THEMYS LV



Ambient to 2400°C



THEMYS



THEMYS ONE / THEMYS ONE+



Ambient to 1600°C



THEMYS DUO



Ambient to 1750°C



THEMYS H2



Ambient to 1750°C



* MS coupling only

CALISTO - THERMAL ANALYSIS SOFTWARE

CALISTO 2.0 is the industry standard thermal analysis software developed for all Setaram instrumentation and applications. It's quick to install and comprises of two independent parts:

- **CALISTO ACQUISITION:** dedicated to the control and data acquisition of our thermal analysis systems.
- **CALISTO PROCESSING:** for the treatment of Thermal Analysis Data independent of instrument type.

CALISTO software includes over 100 customer-requested features and promises to be the most powerful, flexible and intuitive data treatment software in thermal analysis.

See calisto-software.com for more information on the power of Calisto 2.0 software.

PLUG-IN ACCESSORIES



FLEXI WET
Humidity Control

Stand alone wet gas generator



FLEXI HP MS
Evolved gas

High pressure mass spectrometer

- 2D DSC – DIFFERENTIAL SCANNING CALORIMETRY**
Measures heatflow, heat and heat capacity
- 3D 3D CALVET SENSOR**
Three dimensional measurement capturing up to 95% of heat for unparalleled accuracy and precision
- TGA – THERMOGRAVIMETRIC ANALYSIS**
Measures mass loss and uptake, thermal stability, decompositions and solid-gas reactions

- STA – SIMULTANEOUS THERMAL ANALYSIS**
Combines TGA and DSC (or simpler DTA) for more complete thermal characterization
- EGA – EVOLVED GAS ANALYSIS**
Combines your DSC, TGA, or STA with any gas analyser for quantitative analysis using techniques such as FTIR, MS, GC-MS, FTIR/MS or FTIR/GC-MS
- HUMIDITY**
Can be coupled with the FLEXI WET or other relative humidity accessories

- TMA – THERMO MECHANICAL ANALYSIS**
Measures dimension changes, thermal expansion, densification
- CORROSIVE AND REACTIVE GASES**
Able to run in various aggressive atmospheres
- PRESSURE**
Operates under high pressure



- ULTRA-HIGH TEMPERATURE CAPABILITY** to 2400°C with a single furnace
- VARIETY OF ATMOSPHERE CONDITIONS** multiple carrier and reactive gas options
- HIGH ACCURACY & VERSATILE** hang-down symmetrical beam balance specifically designed for TGA applications
- ACCURATE AND SENSITIVE** tri-couple DTA technology
- MODULAR ADAPTATIONS** up to 2400 °C: TGA, DTA, TG-DTA, TMA up to 1600 °C: DSC, TG-DSC
- EXTERNAL COUPLING CAPABILITY** with evolved gas analyzers (FTIR, MS, GCMS, MSFTIR, or FTIR-GCMS)

GENERAL		TGA		STA	
				DTA, TG-DTA	DSC, TG-DSC
Temperature range (°C)		Ambient to 2400		Ambient to 2400	Ambient to 1600
Programmable heating rate (°C/min)		0.01 to 100		0.01 to 100	
Crucible volumes and maximum sample size		55 to 2 500 µl or Height: 20 Diam: 14 mm without crucible		30 to 300 µl	80 to 100 µl
Gas flow	PureGas option	1 carrier gas flow among 3 connected, 1 Mass Flow Controller (MFC)			
	GasBlend option	1 carrier gas flow among 3 connected + 1 auxiliary gas flow, 2 MFC			
	MultiGasBlend option	1 carrier gas flow among 3 connected + 1 pure OR blended auxiliary gas from up to 3 of the 5 connected ones, 4 MFC			
	Corrosive gases option	1 carrier gas flow among 3 connected, 1 Mass Flow Controller (MFC) + 1 corrosive gas line without mass flow control			
Vacuum		Primary (< 1 mbar), forced primary (< 5.10 ⁻² mbar), secondary vacuum options			
BALANCE		HIGH SENSITIVITY	HIGH VERSATILITY	HIGH CAPACITY	
Measuring range (mg)	Small	+/- 5	+/- 200	+/- 300	
	Large	+/- 50	+/- 2 000, AUTO-TARE	+/- 3 000	
Maximum loading capacity (g)		35	35	100	
TGA baseline drift (temperature scanning)^{b,c}		30 µg up to 1000 °C 40 µg up to 1600 °C	35 µg up to 1000 °C 50 µg up to 1700 °C	< 100 µg up to 1 700 °C	
TGA baseline drift precision (µg)^c		+/- 3	+/- 10	-	
Balance resolution (small range) (µg)		0.00059	0.023	0.03	
DTA/DSC		DTA, TG-DTA		DSC, TG-DSC	
Calorimetric precision (%)^{c,e}		+/- 2 % ^f		+/- 1 %	
Temperature precision (°C)^{c,e}		+/- 0.8 °C		+/- 0.4 °C	

b. Under helium flow; c. Typical data; d. Pressure dependent; e. Based on metal standard melting; f. If calibrated

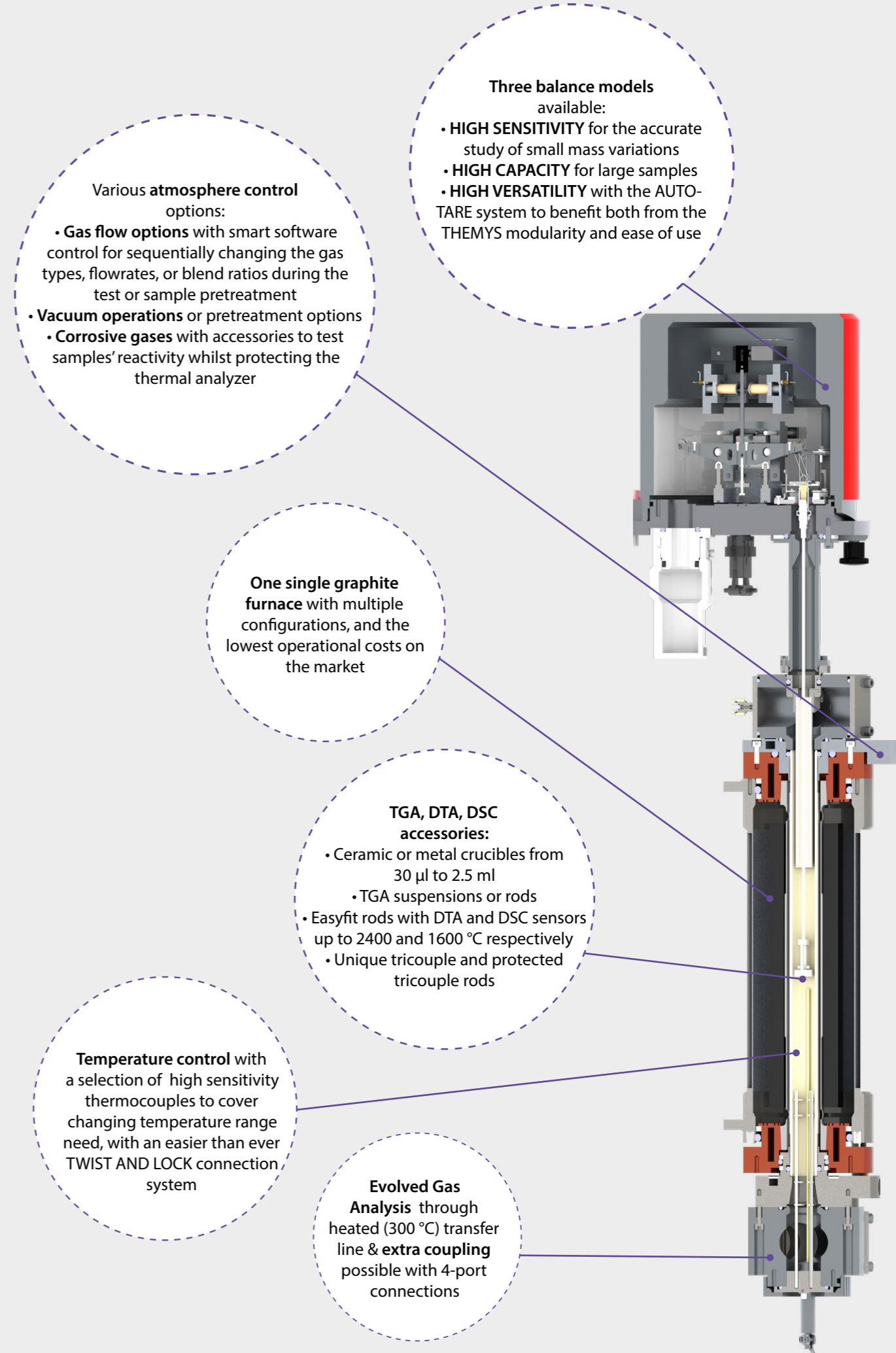

Cross section of the THEMYS STA module



- ULTRA-HIGH TEMPERATURE CAPABILITY**
to 2400°C with a single furnace
- VARIETY OF ATMOSPHERE CONDITIONS**
multiple carrier and reactive gas options
- HIGH ACCURACY & VERSATILE**
hang-down symmetrical beam balance specifically designed for TGA applications
- ACCURATE AND SENSITIVE**
tri-couple DTA technology
- MODULAR ADAPTATIONS**
up to 2400 °C: TGA, DTA, TG-DTA, TMA
up to 1600 °C: DSC, TG-DSC
- EXTERNAL COUPLING CAPABILITY**
with evolved gas analyzers (FTIR, MS, GCMS, MSFTIR, or FTIR-GCMS)

GENERAL		TMA version
Temperature range (°C)		Ambient to 2400
Programmable heating rate (°C/min)		0.01 to 100
Maximum sample size (mm)		Height : 20 Diam : 10
Gas flow	PureGas option	1 carrier gas flow among 3 connected, 1 Mass Flow Controller (MFC)
	GasBlend option	1 carrier gas flow among 3 connected + 1 auxiliary gas flow, 2 MFC
	MultiGasBlend option	1 carrier gas flow among 3 connected + 1 pure OR blended auxiliary gas from up to 3 of the 5 connected ones, 4 MFC
Vacuum		Primary (< 1 mbar), forced primary (< 5.10 ⁻² mbar), secondary vacuum options
TMA		
Resolution (nm)		0.2
Measuring range (mm)		+/- 2

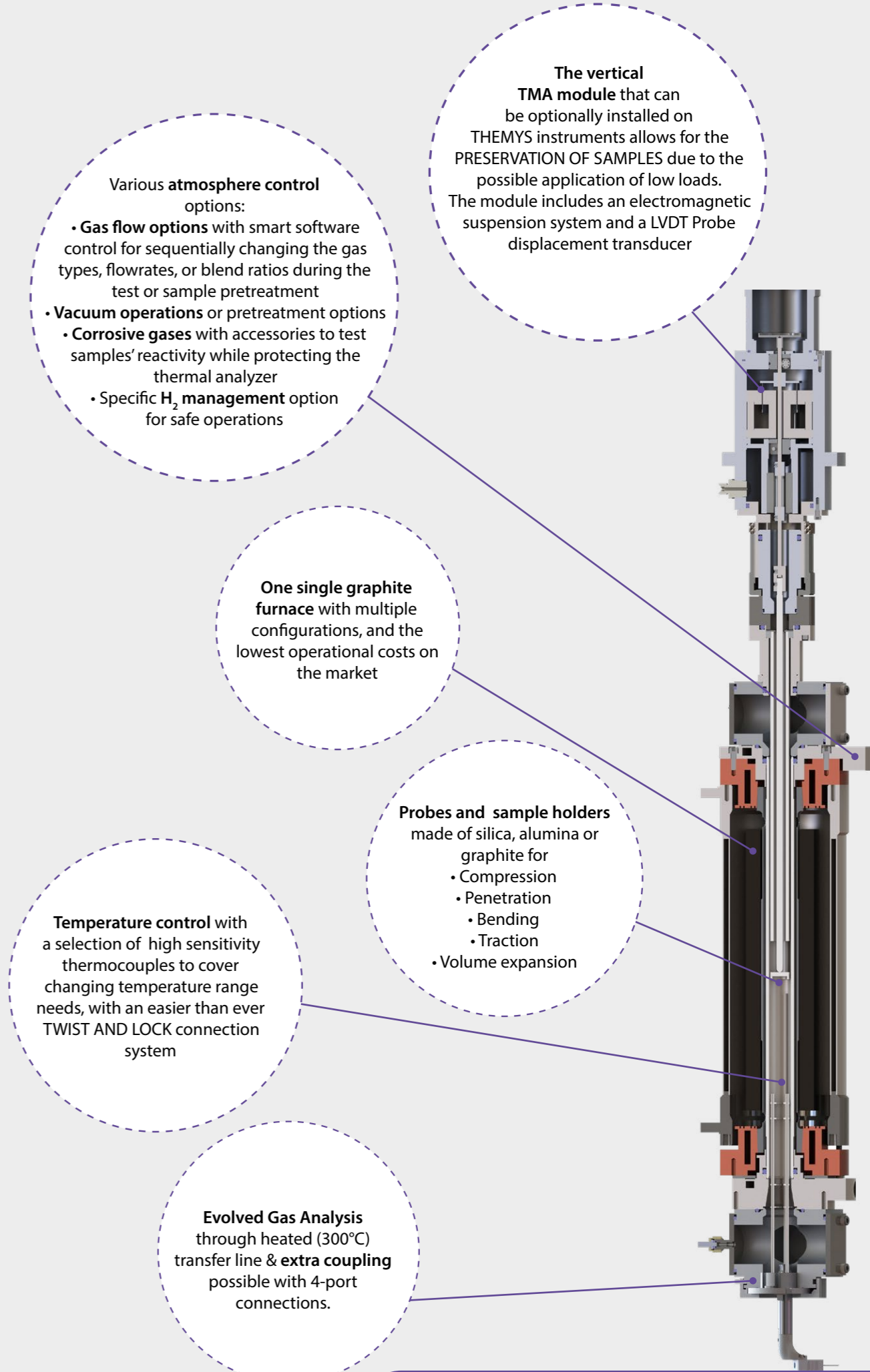

Cross section of the THEMYS TMA module

THEMYS H2

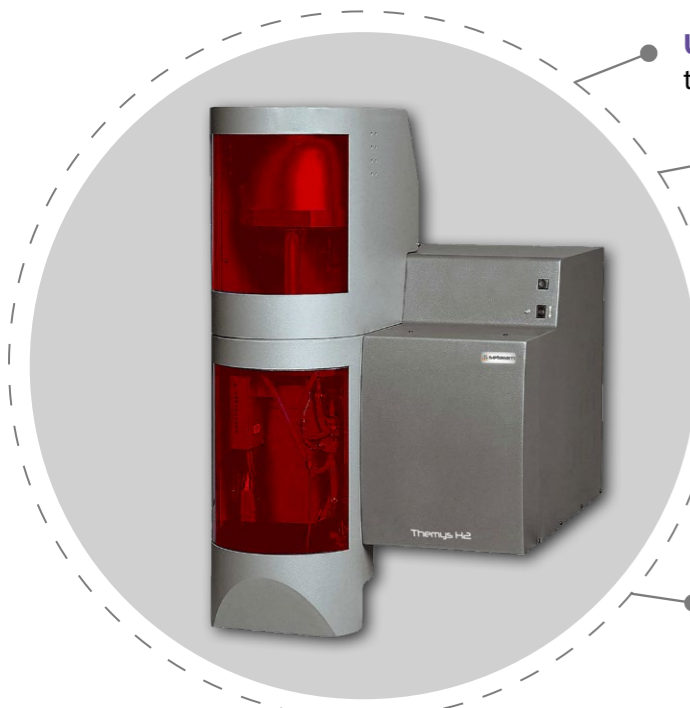

- ULTRA-HIGH TEMPERATURE CAPABILITY**
to 1750°C with a single furnace
- MULTIPLE BUILT-IN SAFETY SYSTEMS**
for instrument and user's secured operations
- HIGH ACCURACY & VERSATILE**
hang-down symmetrical beam balance specifically designed for TGA applications
- EXTERNAL COUPLING CAPABILITY**
to 1000 °C with Mass Spectrometers
- ACCURATE AND SENSITIVE**
Tri- Couple DTA and DSC technologies up to 1000°C
- VERY HIGH TEMPERATURE DTA**
technology up to 1750°C

GENERAL	DTA	DSC	TGA	TMA
Temperature range (°C)	Ambient to 1 750	Ambient to 1 000	Ambient to 1750	Ambient to 1750
Programmable heating rate (°C/min)	0.01 to 100			
Crucibles volumes or maximum sample size	30 to 300 µl	80 to 100 µl	55 to 2 500 µl or Height: 20 Diam: 14mm without crucible	Height : 20 mm Diam : 10 mm
Gas flow	1 carrier gas flow among 3 connected including a specific H2 line + 1 auxiliary gas flow, 2 MFC, safety system including O2 and H2 detectors			
Vacuum	Forced primary (< 5.10 ⁻² mbar), hydrogen resistant vacuum pump			
MEASUREMENTS	DTA	DSC	TGA	TMA
Measuring range			+/- 20 mg +/- 200 mg	+/- 2 mm
Maximum loading capacity		35 g		
Resolution	0.4µW	1µW	0.002 µg 0.02µg	0.2 nm
Measurement precision	Enthalpy 1.4% ^{b,c}	Enthalpy 0.9% ^b	+/-0.06% ^d	+/-0.08 10 ⁻⁶ /°C ^e
Temperature precision	0.35°C ^{b,c}	0.7°C ^b		

^aµV=microvolts, values in mW depend on the type of rod used; ^bbased on metal standard melting; ^cif calibrated; ^dbased on standard material decomposition; ^ebased on thermal expansion measurement of sapphire standard.

A hydrogen probe and an oxygen probe are placed at the instrument's outlet to detect the presence of these gases in the exhaust gases.

An independent control unit :
 • prevents opening the furnace and balance if hydrogen is detected by the probe
 • prevents hydrogen introduction in the furnace if oxygen is detected by the probe
 • warns the user with visual alarms
 • features an emergency stop button that controls the hydrogen supply

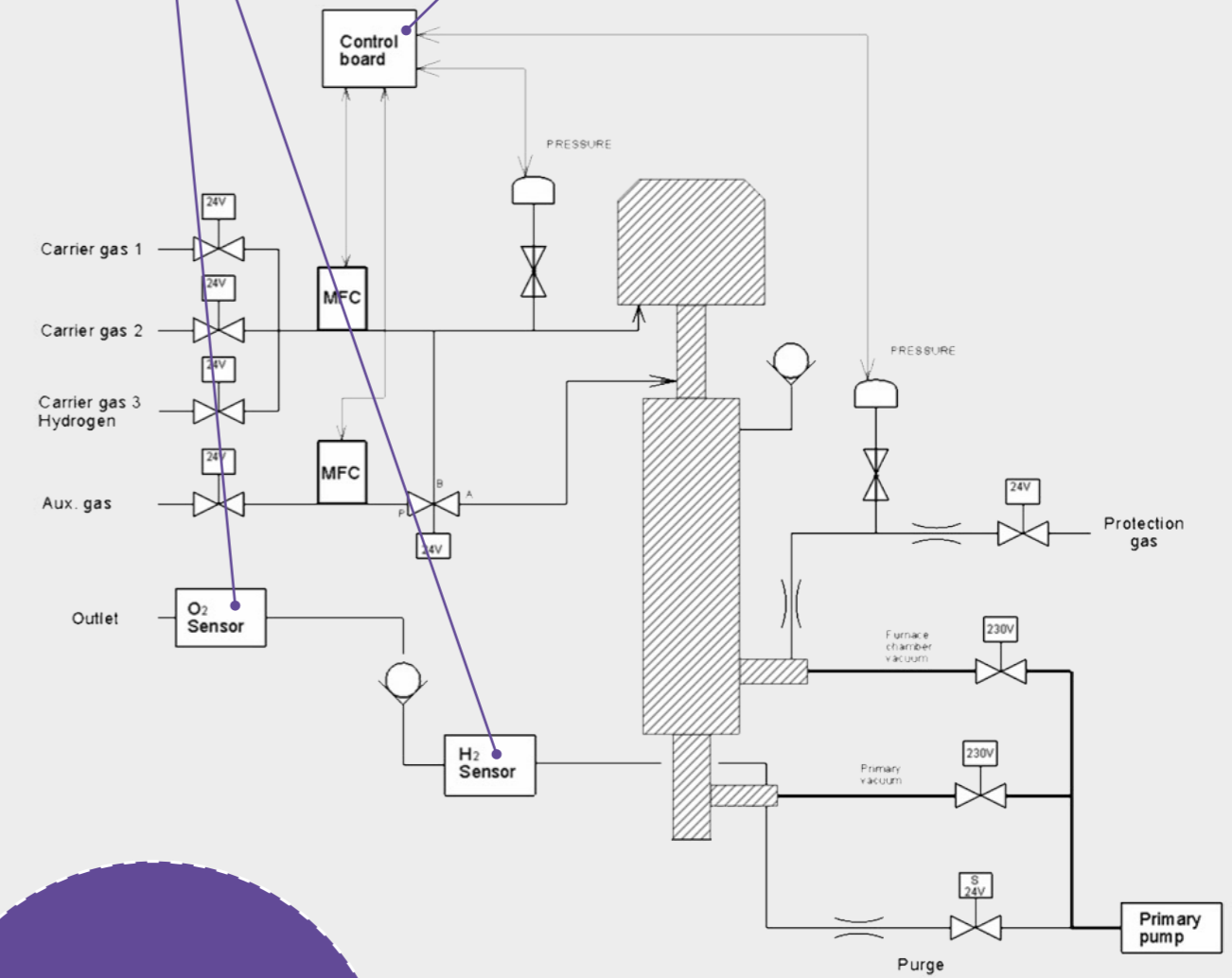

Additional safety features
 • The furnace cannot be opened when under vacuum, or when its temperature exceeds 70°C
 • Heating is stopped if at full power for more than one minute or if the control thermocouple fails

Schematics of THEMYS H2

**THEMYS ONE
THEMYS ONE+**



- HIGH TEMPERATURE CAPABILITY**
with the convenience of ONE FURNACE to reach temperatures as high as 1150 or 1600 °C
- HIGH SENSITIVITY BALANCE FOR THE DETECTION OF SMALL MASS VARIATIONS**
specifically designed for TGA analysis
- PLUG AND PLAY INTERCHANGEABLE RODS**
to perform TGA, TG-DSC, TG-DTA, and 3D high sensitivity calorimetry / Cp measurements
- EXTERNAL COUPLING CAPABILITY**
evolved gas analyzers (FTIR, MS, GC/MS, MS-FTIR, or FTIR-GC/MS)
- 32 POSITION AUTOSAMPLER**
on the THEMYS ONE+ version

GENERAL	TGA	STA	DTA/DSC
Temperature range (°C)		Ambient to 1 150 Ambient to 1 600	
Programmable heating and cooling rate (°C/min)		0.01 to 100	
Furnace cooling		30 min (1 150 to 50°C) 32 min (1 600 to 50°C)	
Gas flow	Base: two gas inlets (inert or reactive) Option: selection from 3 different carrier gases (controlled flow up to 200 ml/min), mixing of one of these carrier gases with another «auxiliary » gas (controlled flow up to 16 ml/min)		
Vacuum	< 10 ⁻¹ mbar. Option for operations under controlled vacuum down to 30 mbar.		
Weight	60 kg / 132 lbs		
Dimensions (Height / Width / Depth)	700 / 500 / 440 mm (27.6 / 19.7 / 17.3 in)		
BALANCE			
Maximum balance capacity (g)	20		-
Weight range (mg)	+/- 1 000; +/- 200		-
Balance resolution (small range) (µg)	0.02		-
DTA/DSC			
DSC rod – resolution (µW)	-	0.4 / 10 dependent on sensor	
3D Cp rod – Cp accuracy	-	down to within 2 % ^a	

a. Value depends on tested material type

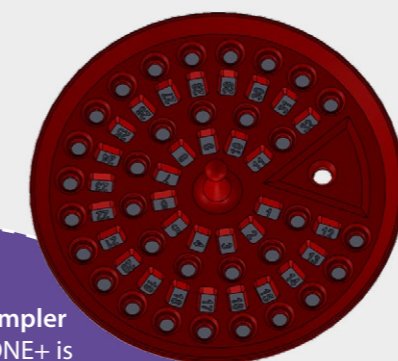

The Autosampler of THEMYS ONE+ is equipped with a 32 position carousel for samples and references.
The 3-pin gripper automatically configures to the different sensors and crucibles to give you the most user-friendly system available.

Optional Evolved Gas Analysis coupling tool heated up to 300°C to avoid condensation of most gases and vapors and with two gas outlets for triple coupling (like TG-MS-FTIR)

Coiled metal furnace existing in two distinct temperature ranges (1 150 °C and 1 600 °C). It has been designed to provide a **homogeneous temperature zone** covering both the sample crucible and the measurement rod area

Top-loading balance based on the same principle as the other symmetrical beam balance models, and **temperature controlled for an improved stability**

TGA, DTA, DSC accessories:

- Ceramic or metal crucibles from 80 µl to 1 ml
- Easyfit TGA, DTA, and DSC rods up to 1150 or 1600 °C
- 3D Cp rod using multiple thermocouples surrounding large crucibles (380 µl) for more accurate high temperature calorimetry measurements

Various atmosphere control options:

- Gas flow (inert or reactive) circuit
- Option: fully automated gas control panel with two mass flow controllers
- Vacuum

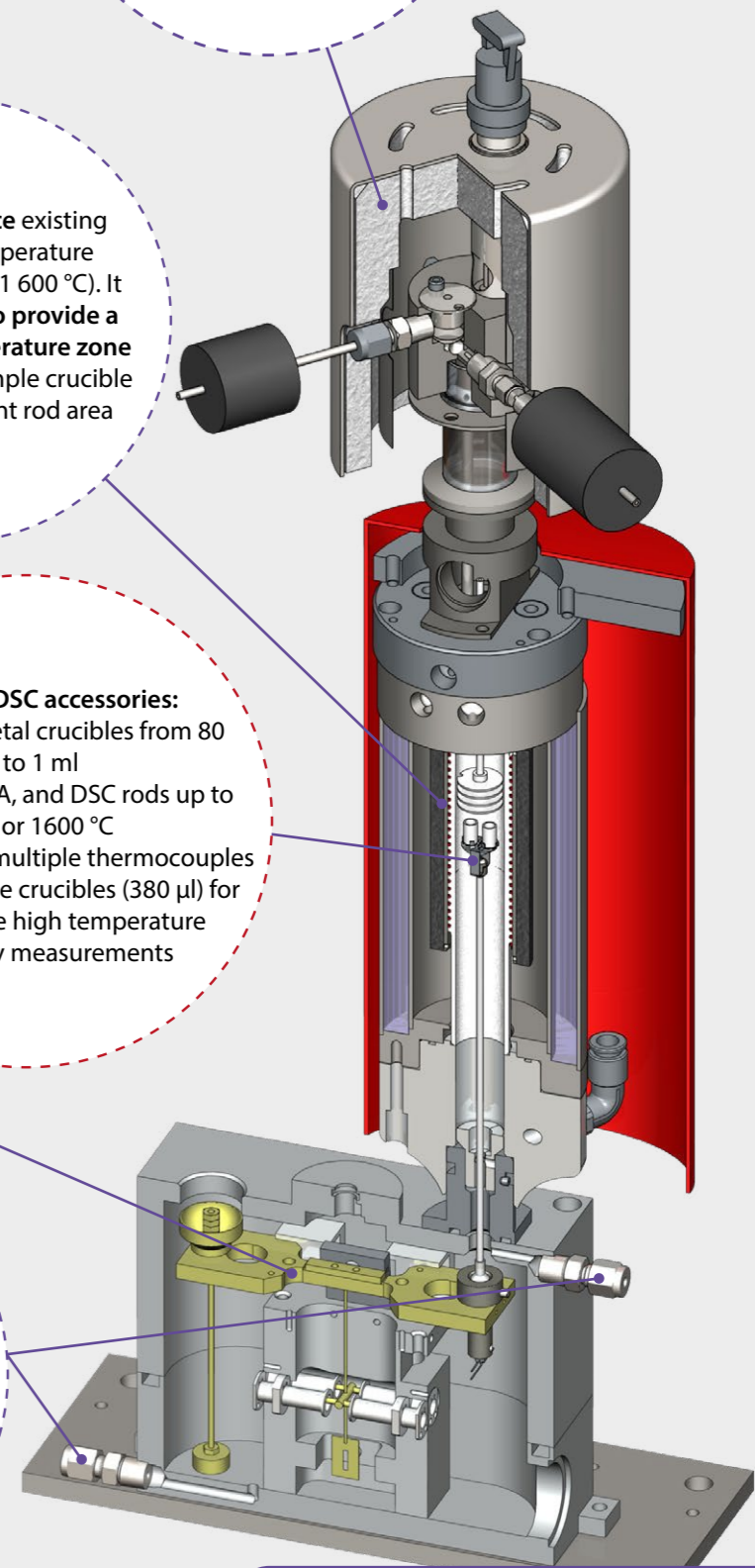

Cross sections of the THEMYS ONE

THEMYS DUO



- ULTRA-HIGH TEMPERATURE CAPABILITY**
to 1750 °C with the same dual furnace
- HIGHEST ACCURACY WITH ITS HANG-DOWN SYMMETRICAL BEAM BALANCE**
eliminate drift & buoyancy effect, improve gas/sample interaction
- MODULAR ADAPTATIONS ALLOWING**
up to 1750 °C: TGA, DTA, TG-DTA
up to 1600 °C: DSC, TG-DSC
- ACCURATE AND SENSITIVE**
Tri-couple DTA technology
- VARIETY OF ATMOSPHERE CONDITIONS**
multiple carrier and reactive gas options
- EXTERNAL COUPLING CAPABILITY**
designed for evolved gas analyzers (FTIR, MS, GCMS, MSFTIR, or FTIR-GCMS)

GENERAL		TGA	DTA, TG-DTA	STA DSC, TG-DSC
Temperature range (°C)		Ambient to 1750	Ambient to 1750	Ambient to 1600
Programmable heating rate (°C/min)		0.01 to 100		
Crucibles volumes and maximum sample size		55 to 1 500 µl or Height: 20 Diam: 14 mm without crucible	20 to 300 µl	75 to 110 µl
Gas flow	PureGas option	1 carrier gas flow among 3 connected, 1 Mass Flow Controller (MFC)		
	GasBlend option	1 carrier gas flow among 3 connected + 1 auxiliary gas flow, 2 MFC		
	Corrosive gases option	1 carrier gas flow among 3 connected, 1 Mass Flow Controller (MFC) + 1 corrosive gas line without mass flow control		
Vacuum		Primary (< 1 mbar), forced primary (< 5.10 ⁻² mbar) options		
Weight		145 kg / 320 lbs		
Dimensions (Height / Width / Depth)		170 / 60 / 55 cm (66.9 / 23.6 / 21.6 in)		
BALANCE				
Measuring range (mg)	Small	+/- 20		
	Large	+/- 200		
Maximum loading capacity (g)		35		
TGA baseline drift (temperature scanning) ^{b,c}		5 µg up to 1700 °C		
TGA baseline drift precision (µg) ^c		+/- 1		
Balance resolution (small range) (µg)		0.002		
DTA/DSC		DTA, TG-DTA	DSC, TG-DSC	
Calorimetric precision ^{c,e}		+/- 2 % ^f	+/- 1 %	
Temperature precision ^{c,e}		+/- 0.8 °C	+/- 0.4 °C	
Temperature accuracy ^{c,e}		+/- 0.4 °C	+/- 0.25 °C	

b. Under helium flow; c. Typical data; e. Based on metal standard melting; f. If calibrated
Specifications are subject to change

THEMYS DUO's hang-down Symmetrical Beam Balance continuously measures the **mass difference between a sample and an inert reference material**, both placed under the exact same temperature and atmosphere conditions in two distinct but identical heating zones.

It leads to **near-zero drift or buoyancy effect**, and thus performs the best long term stability studies.

The hang-down principle of the system **improves the gas/sample interaction** with the **maximum exposure of sample to gas environment**.

- Various **atmosphere control** options:
- **Gas flow options** with software control for sequentially changing the gas types, flowrates, or blend ratios during the test or sample pretreatment
 - **Vacuum operations** or pretreatment options
 - **Corrosive gases** with accessories to test samples' reactivity whilst protecting the thermal analyzer

The **dual furnace of THEMYS DUO is composed of two identical graphite heating elements and alumina protective tubes**, to perfectly adjust the experimental conditions of the sample and of the inert reference material

- TGA, DTA, DSC accessories:**
- Ceramic or metal crucibles from 20µl to 1.5ml
 - TGA suspensions or rods
 - Rods with DTA and DSC sensors up to 1750 and 1600°C respectively
 - Unique tricouple DTA rods

Temperature control with a selection of high sensitivity thermocouples to cover changing temperature range needs

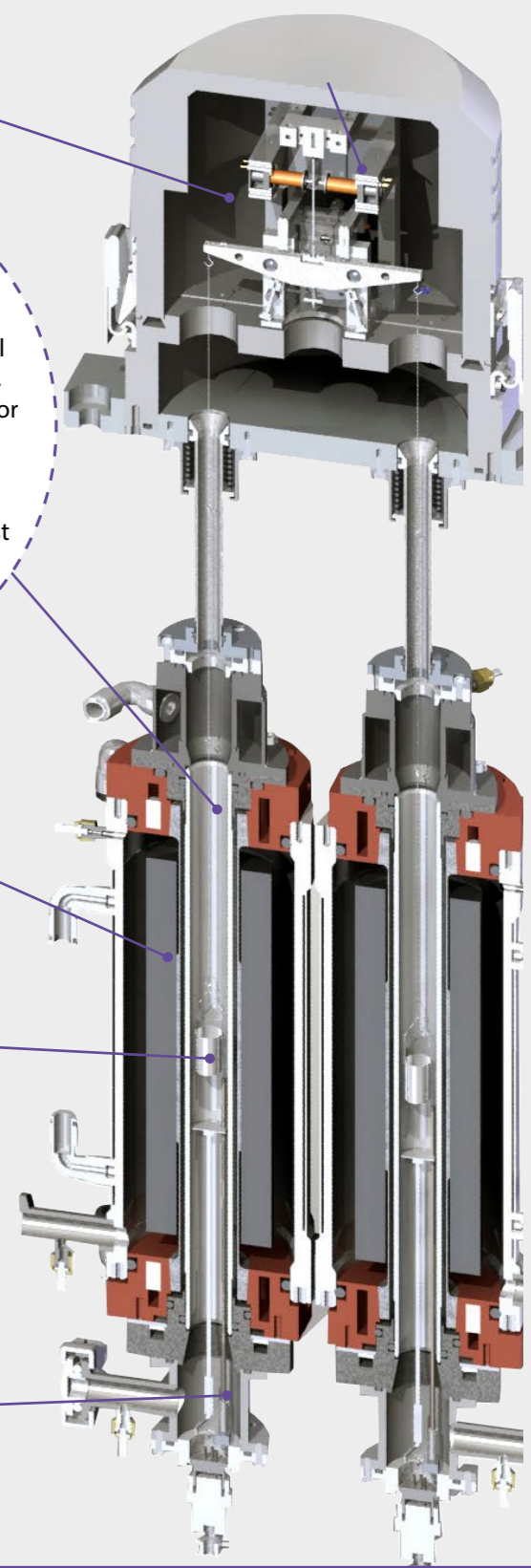

Cross section of the THEMYS DUO

THEMYS LV



- ULTRA-HIGH TEMPERATURE CAPABILITY** to 2000 °C with a single furnace
- LARGE VOLUMES** for testing more significant sample sizes
- HIGH ACCURACY & VERSATILITY** hang-down symmetrical beam balance, specifically designed for TGA applications
- MODULAR ADAPTATION ALLOWING** up to 2000 °C: TGA, DTA, TG-DTA, TMA up to 1600 °C: TG-DSC, DSC
- TMA MODULE WITH PRESERVATION OF SAMPLES** due to low load vertical system
- EXTERNAL COUPLING CAPABILITY** designed for evolved gas analyzers

GENERAL		TGA	STA		TMA
			DTA, TG-DTA	DSC, TG-DSC	
Temperature range (°C)		Ambient to 2000	Ambient to 2000	Ambient to 1600	Ambient to 2000
Programmable heating rate (°C/min)		0.01 to 20			
Crucibles volumes and maximum sample size		4.5 to 18.1 ml or Height: 80 Diam: 20 mm without crucible	220 to 500 µl	360 to 420 µl	Height : 50 Diam : 15 mm
GasBlend option		1 carrier gas flow among 3 connected + 1 auxiliary gas flow, 2 MFC			
Corrosive gases option		1 carrier gas flow among 3 connected, 1 Mass Flow Controller (MFC) + 1 corrosive gas line without mass flow control			
Vacuum		Primary (< 1 mbar), forced primary (< 5.10 ⁻² mbar)			
BALANCE					
Measuring range (mg)	Small	+/- 200			
	Large	+/- 2 000			
Maximum loading capacity (g)		100			
TGA baseline drift (temperature scanning)^{b,c}		< 100 µg up to 1 700 °C			
Balance resolution (small range) (µg)		0.02			
DTA/DSC		DTA, TG-DTA	DSC, TG-DSC		
Temperature precision (°C) ^{c,e}		+/- 2			
Temperature accuracy (°C) ^{c,e}		+/- 1			
TMA					
Resolution (nm)		1.6			
Measuring range (mm)		+/- 6			

b. Under helium flow; c. Typical data; e. Based on metal standard melting
Specifications are subject to change

By design, the hang-down balance of THEMYS LV is robust and adapted to heavier samples with larger mass variations.

As with THEMYS, the THEMYS LV balance module can be exchanged with a vertical TMA module for thermal expansion measurements.

The hang-down principle of the system improves the gas/sample interaction with the maximum exposure of sample to gas environment.

- Various atmosphere control options
- Gas flow options with software control for sequentially changing the gas types, flowrates, or blend ratios during the test or sample pretreatment
 - Vacuum operations or pretreatment options
 - Corrosive gases with accessories to test samples' reactivity while protecting the thermal analyzer

THEMYS LV furnace is amongst the largest on the thermal analyzers market. It can test samples as large as 20 mm diameter and 80 mm height while limiting the thermal gradient and thus preserving the measurement accuracy.

This single graphite furnace combined with multiple configurations provides various test conditions and thermal data.

- TGA, DTA, DSC accessories:
- Ceramic or metal crucibles from 220 µl to 18.1ml
 - TGA suspensions or rods
 - rods with DTA and DSC sensors up to 2000 and 1600 °C respectively.

Temperature control with a selection of high sensitivity thermocouples to cover changing temperature range needs

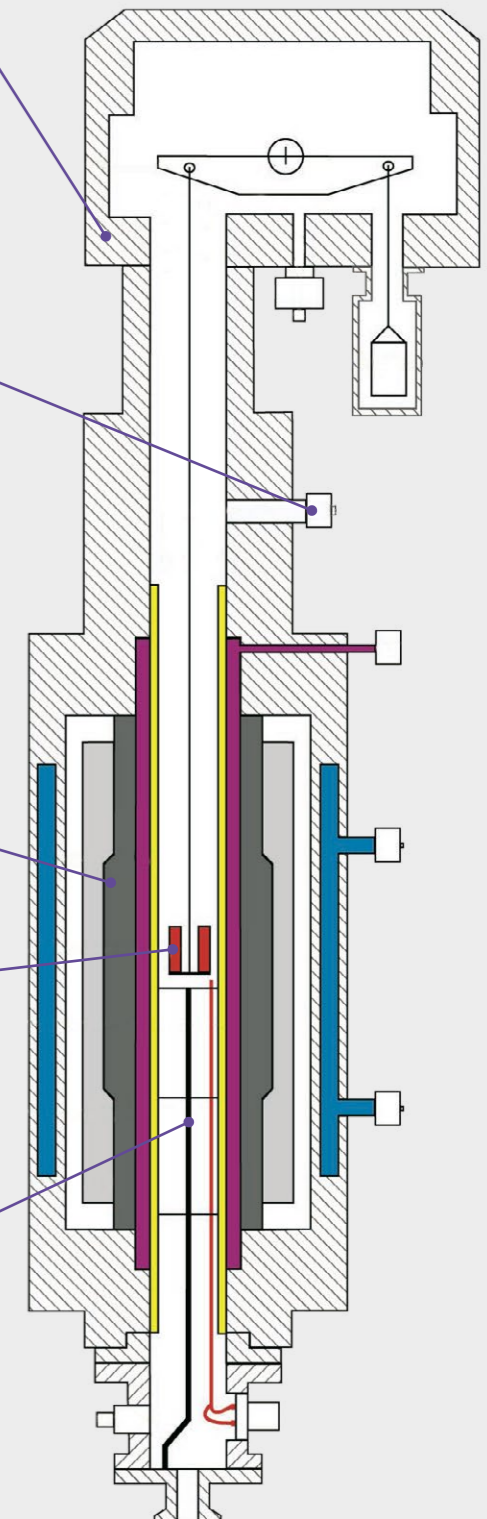

Cross section of the THEMYS LV



HIGH TEMPERATURE AND HIGH PRESSURE CAPABILITY
up to 1200 °C and 150 bar with a single furnace, to replicate real process conditions

HIGH ACCURACY & VERSATILITY
hang-down symmetrical beam balance, specifically designed for TGA applications

- continuously measures sample mass variations
- drastically limits the TGA signal background noise and reduces drift
- improves gas/sample interaction

BUILT-IN SAFETY
compliant with European Pressure Equipment Directive 2014/68/EU - group 2 gases (non-explosive, non-flammable, non-toxic)

GENERAL		
Temperature range (°C)		Ambient to 1200
Programmable heating rate (°C/min)		0.01 to 100 ^a
Crucibles volumes and maximum sample size		1300 µl
Gas flow	Single gas flow option	1 carrier gas flow controlled by 1 Mass Flow Controller (MFC)
	Advanced gas panel option	1 carrier gas flow among 3 connected + 1 auxiliary gas flow, 2 MFC
Vacuum		Primary (< 1 mbar), forced primary (< 5.10 ⁻² mbar)
BALANCE		
Measuring range (mg)	Small	+/- 200
	Large	+/- 2000
Maximum loading capacity (g)		35
TGA baseline drift precision (µg) ^c		+/- 200
Balance resolution (small range) (µg)		0.0023

a. Value at Patm, may vary according to pressure; c. Typical data

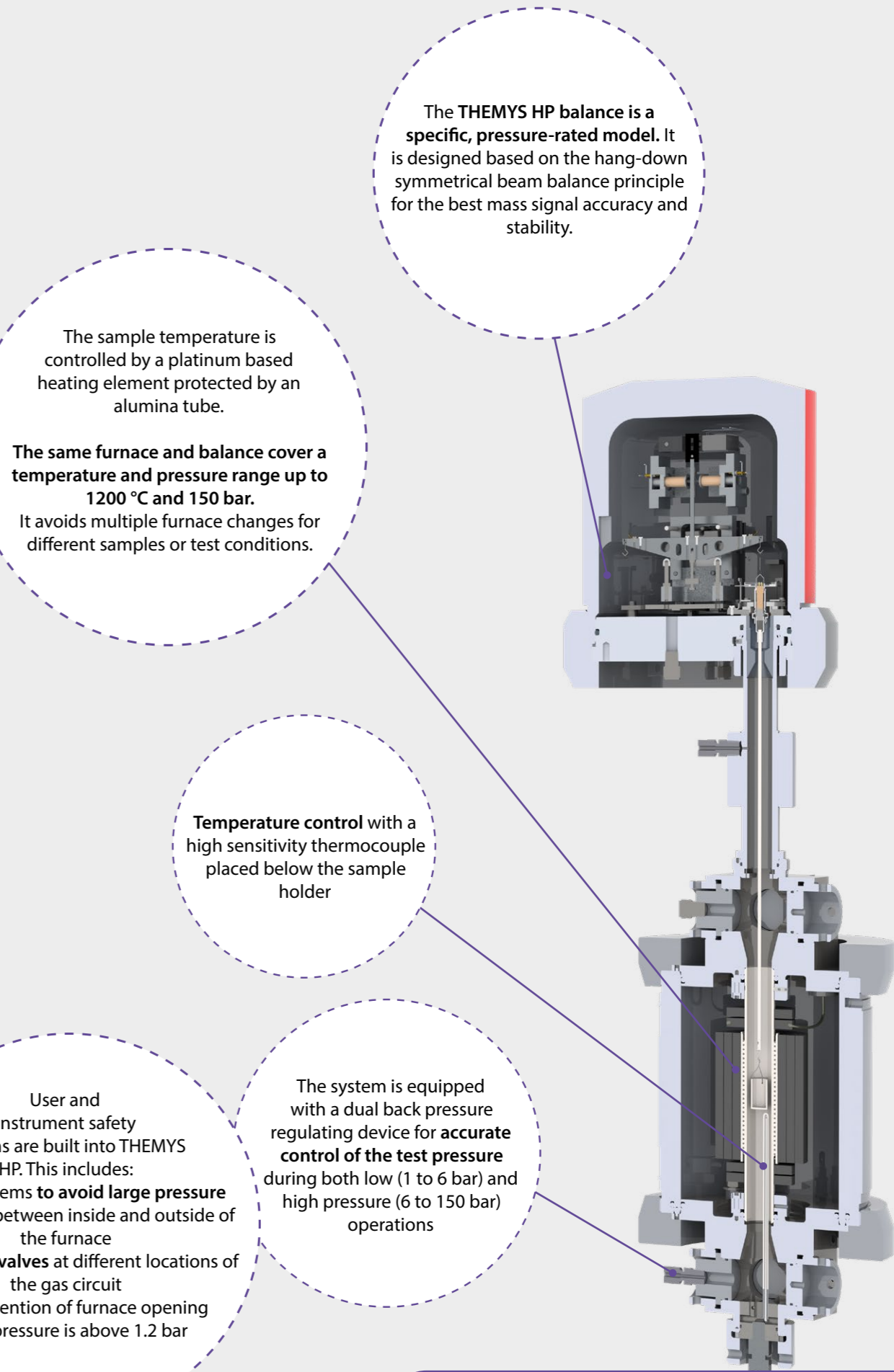

The THEMYS HP balance is a specific, pressure-rated model. It is designed based on the hang-down symmetrical beam balance principle for the best mass signal accuracy and stability.

The sample temperature is controlled by a platinum based heating element protected by an alumina tube.

The same furnace and balance cover a temperature and pressure range up to 1200 °C and 150 bar. It avoids multiple furnace changes for different samples or test conditions.

Temperature control with a high sensitivity thermocouple placed below the sample holder

User and instrument safety systems are built into THEMYS HP. This includes:

- Safety systems to avoid large pressure differences between inside and outside of the furnace
- Four safety valves at different locations of the gas circuit
- The prevention of furnace opening when pressure is above 1.2 bar

The system is equipped with a dual back pressure regulating device for accurate control of the test pressure during both low (1 to 6 bar) and high pressure (6 to 150 bar) operations

Cross section of the THEMYS HP



Switzerland – France – China – United States – India – Hong Kong
For contact details: www.setaramsolutions.com or setaram@kep-technologies.com

